

Vertical section

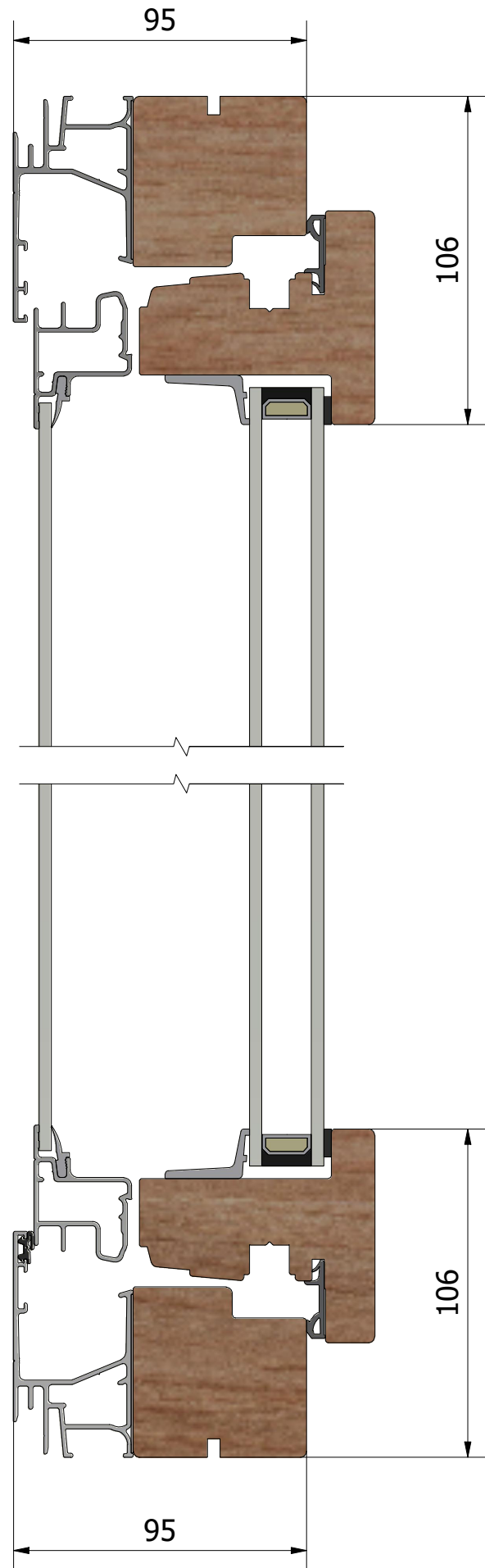

Horizontal section

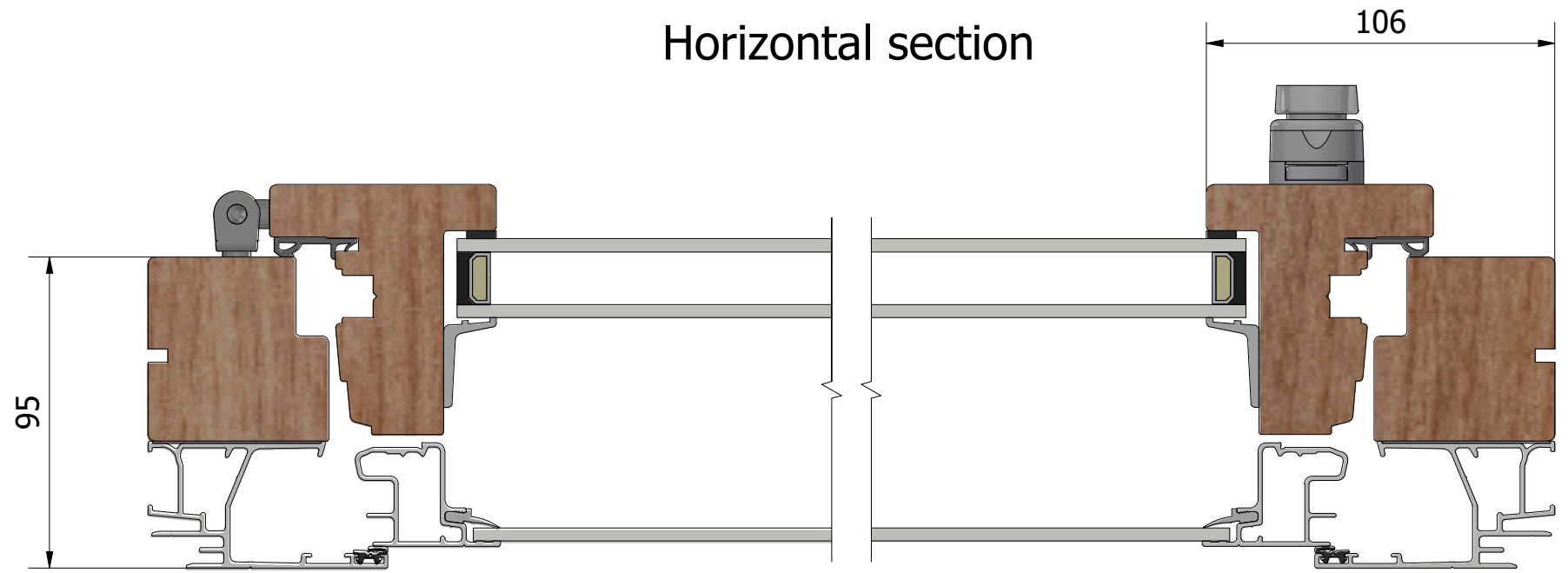

Floating mullion

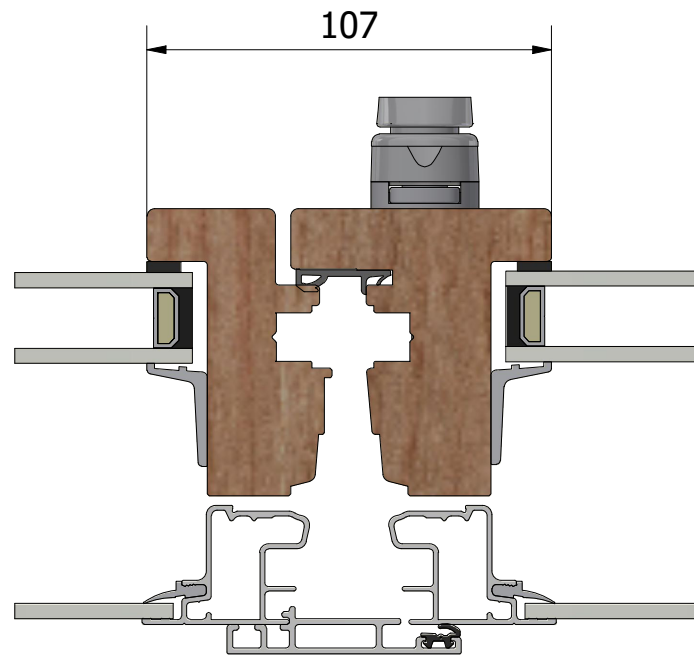

Mullion

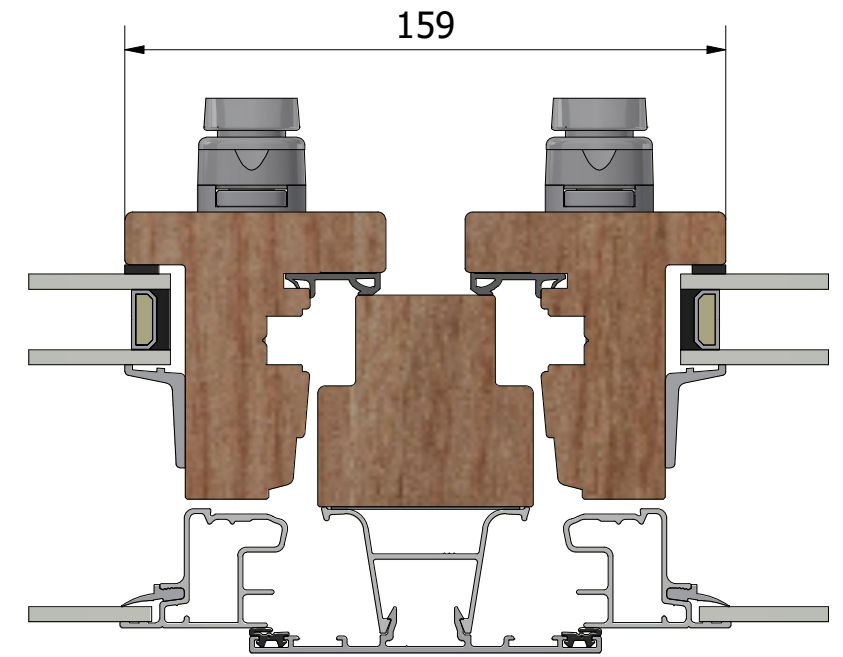

Weep hole

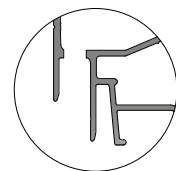

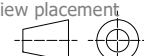
Revision no.	Revision description			
General tolerances ISO 2768-1, m		Product name LIF951.2		Created by Alexander
Sheet size A3	Scale 1 : 2	Page 1	Description Stil inward opening window, 2+1 high performance glazing	
 View placement 			File name MP-LIF951.2EN_260.dwg	Drawing no. MP-LIF951.2EN_260
				Creation date 2026-05-18